

$K \rightarrow \pi \nu \bar{\nu}$ DECAYS:
PROGRESS AND PROSPECTS

Douglas Bryman
University of British Columbia



Blois 2002

Overview of Rare Kaon Decays

State of the art: single event sensitivity, 10^{-12}

<p><i>Exotic Searches</i></p>	<p>$K_L^0 \longrightarrow \mu e$ LFV $K^+ \longrightarrow \pi^+ f$ "Axions".</p>	<p>$<4.7 \cdot 10^{-12}$</p>
<p><i>SM Parameters and BSM Physics</i></p>	<p>$K_L^0 \longrightarrow \mu^+ \mu^-$ V_{td} $K^+ \longrightarrow \pi^+ \nu \bar{\nu}$ V_{td} $K_L^0 \longrightarrow \pi^0 e^+ e^-$ CP violation $K_L^0 \longrightarrow \pi^0 \nu \bar{\nu}$ CP violation</p>	<p>10^{-8}: 6200 events 10^{-10}: 2 events</p>
<p><i>Low Energy QCD Chiral Perturbation Theory</i></p>	<p>$K_L^0 \rightarrow e^+ e^-$ $K_L^0 \rightarrow \gamma l^+ l^-$ $l = e, \mu$ $K^+ \rightarrow \pi^+ l^+ l^-$...Radiative decays</p>	<p>10^{-11}: 4 events</p>

Standard Model CP Violation

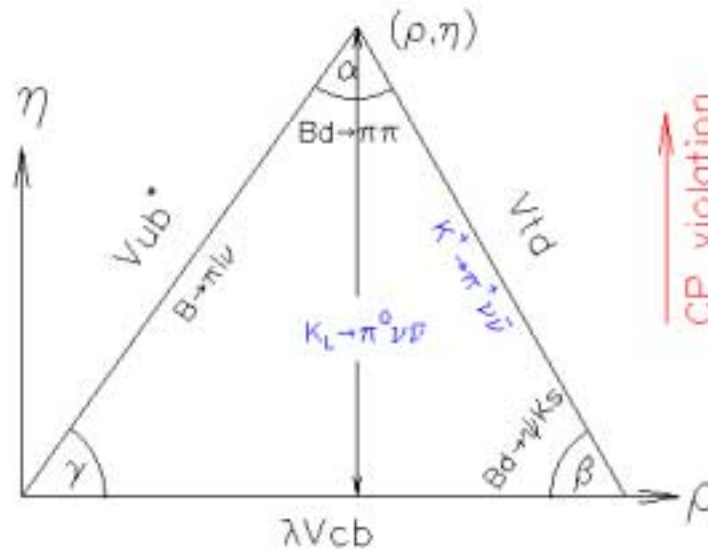

$$\left\{ \begin{array}{l} \text{"Jarlskog invariant" } |J_{CP}| \\ 2A_{\Delta} = \left| \text{Im} V_{ts}^* V_{td} \right| \lambda \left(1 - \frac{\lambda^2}{2} \right) \end{array} \right\}$$

Four super-clean processes will challenge the Standard Model:



$$\left| V_{ts}^* V_{td} \right|$$

E949, CKM



$$\text{Im} (V_{ts}^* V_{td})$$

KOPIO



$$\sin(2\beta)$$

BABAR, BELLE, CDF, D0

$$\frac{x_s}{x_d}$$

$$\left| \frac{V_{ts}}{V_{td}} \right|$$

CDF, D0, LHCb, BTeV

$K \rightarrow \pi \nu \bar{\nu}$ in the Standard Model

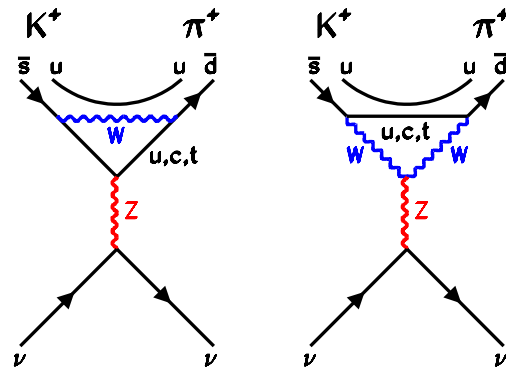
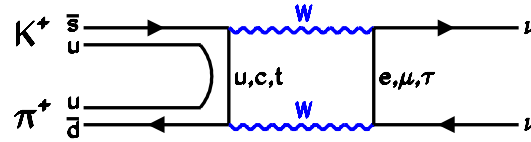

	$K^+ \rightarrow \pi^+ \nu \bar{\nu}$	$K_L^0 \rightarrow \pi^0 \nu \bar{\nu}$
Top Quark Dependence	$ \lambda_t = V_{ts}^* V_{td} $	$\text{Im}(\lambda_t) = \text{Im}(V_{ts}^* V_{td})$
SM BR (10^{-11})	7.2 ± 2.1	2.6 ± 1.2
Est. Theory Uncertainty	7% (charm)	2%

- Negligible long distance effects (10^{-13}).
- Hadronic matrix elements from isospin analog $K^+ \rightarrow \pi^0 e^+ \nu_e$.

Standard Model (*Buras*):

$$\text{Im } \lambda_t = \text{Im } V_{ts}^* V_{td} = \eta A^2 \lambda^5$$

$$\begin{aligned} \mathcal{R}(K_L^0 \rightarrow \pi^0 \nu \bar{\nu}) &= 1.8 \times 10^{-10} \left(\frac{\text{Im } \lambda_t}{\lambda^5} X(x_t) \right)^2 \\ &\sim 4.1 \times 10^{-10} A^4 \eta^2 = 2.6 \pm 1.2 \times 10^{-11} \end{aligned}$$

$$\mathcal{R}(K^+ \rightarrow \pi^+ \nu \bar{\nu}) \sim 1.0 \times 10^{-10} A^4 \left[\eta^2 + (\rho_0 - \rho)^2 \right] = 7.2 \pm 2.1 \times 10^{-11}$$

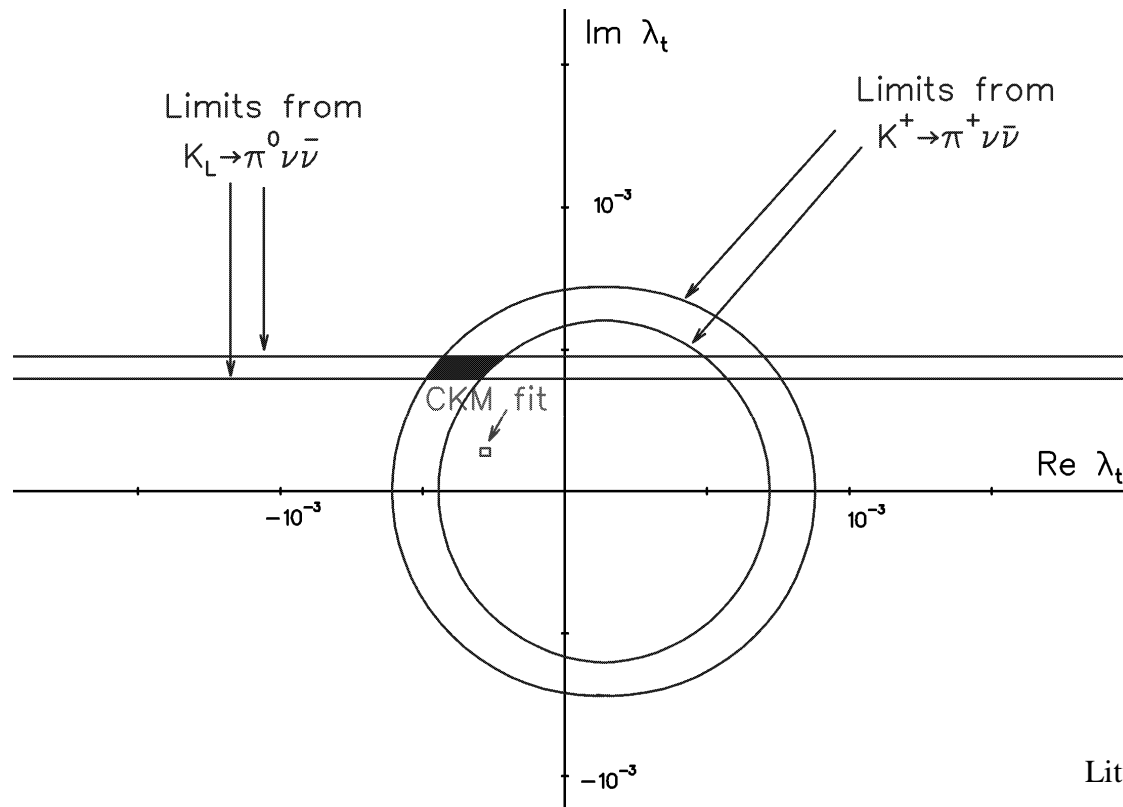

Littenberg

$$\mathbf{B} \rightarrow \psi K_S \text{ and } \mathbf{K} \rightarrow \pi \nu \bar{\nu}$$

Differences sensitive to new physics – virtually free of uncertainties.

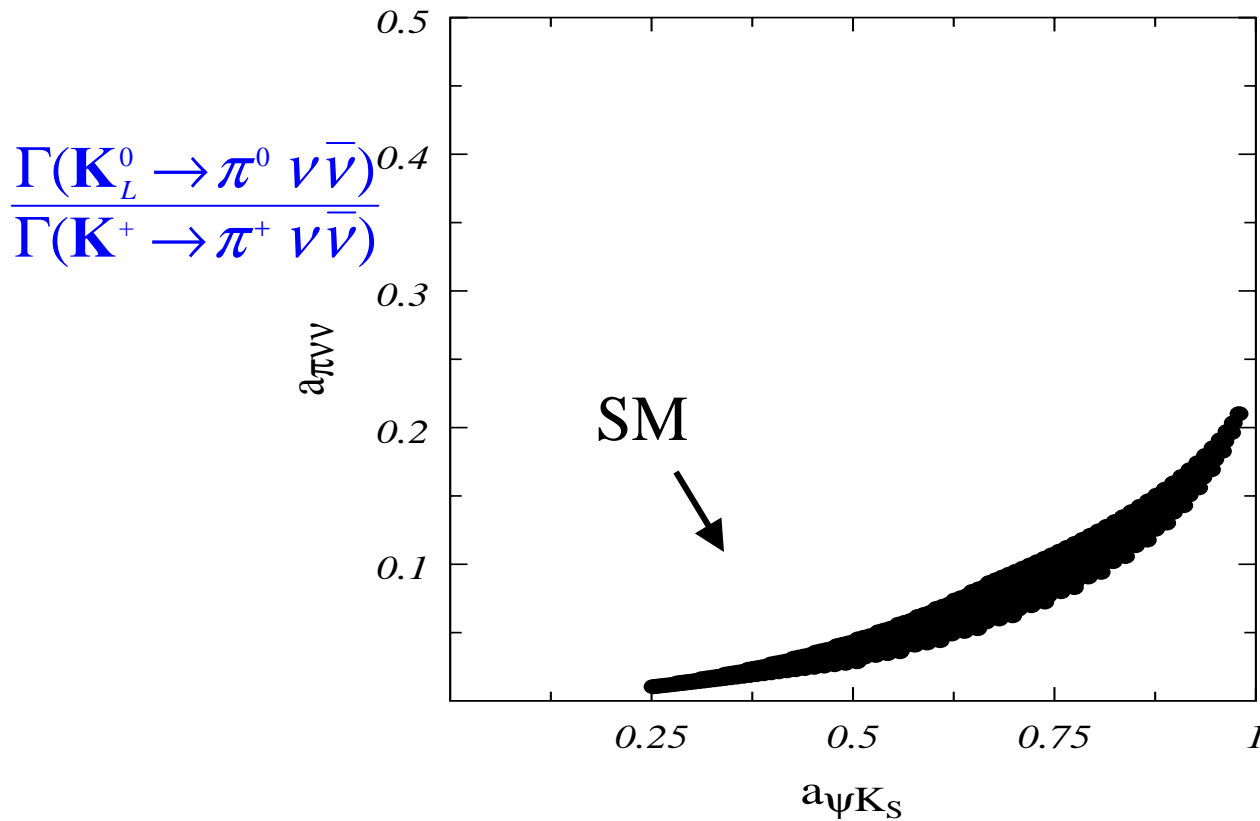

$$\frac{\Gamma(\mathbf{K}_L^0 \rightarrow \pi^0 \nu \bar{\nu})}{\Gamma(\mathbf{K}^+ \rightarrow \pi^+ \nu \bar{\nu})}$$

Candidates:

- * Low energy SUSY
- * Minimal Flavor Violation
- * Multiple Higgs
- * New Physics in $B_d - \bar{B}_d$
- * New Physics in $s \rightarrow d \nu \bar{\nu}$

CP asymmetry in $\mathbf{B} \rightarrow \psi K_S$

(Nir and Worraah, Phys. Lett. **B319** 1998)

(Buras,1999)

Comparison of Precision from Future K and B Measurements

$$\sigma(|V_{cb}|) = \pm 0.002(0.001)$$

	$K \rightarrow \pi \nu \bar{\nu}$	B-Factory Era	LHCb/BTeV
$\sigma(V_{td})$	$\pm 10\%(9\%)$	$\pm 5.5\%(3.5\%)$	$\pm 5\%(2.5\%)$
$\sigma(\bar{\rho})$	$\pm 0.16(0.12)$	± 0.03	± 0.01
$\sigma(\bar{\eta})$	$\pm 0.04(0.03)$	± 0.04	± 0.01
$\sigma(\sin 2\beta)$	± 0.05	± 0.06	± 0.02
$\sigma(\text{Im } \lambda_t)$	$\pm 5\%$	$\pm 14\%(11\%)$	$\pm 10\%(6\%)$

BNL E787(E949)

Measurement of $K^+ \rightarrow \pi^+ \nu \bar{\nu}$

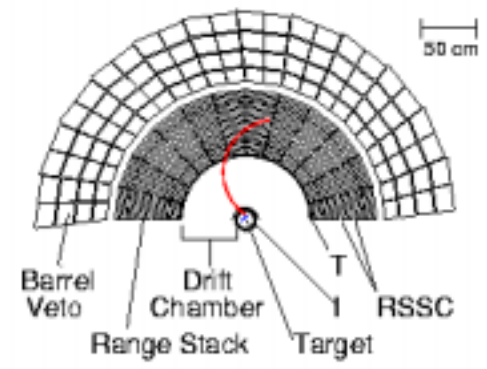
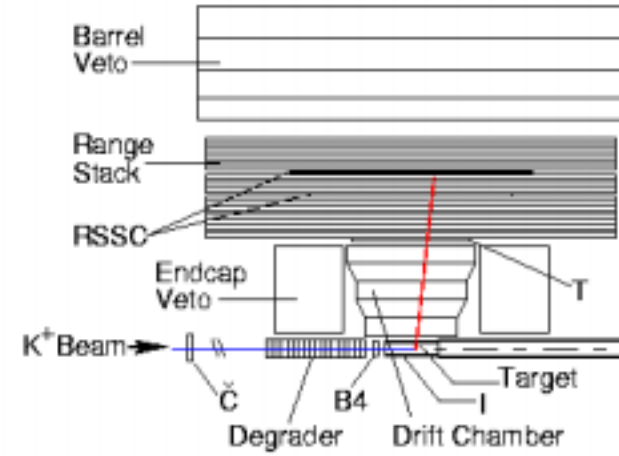
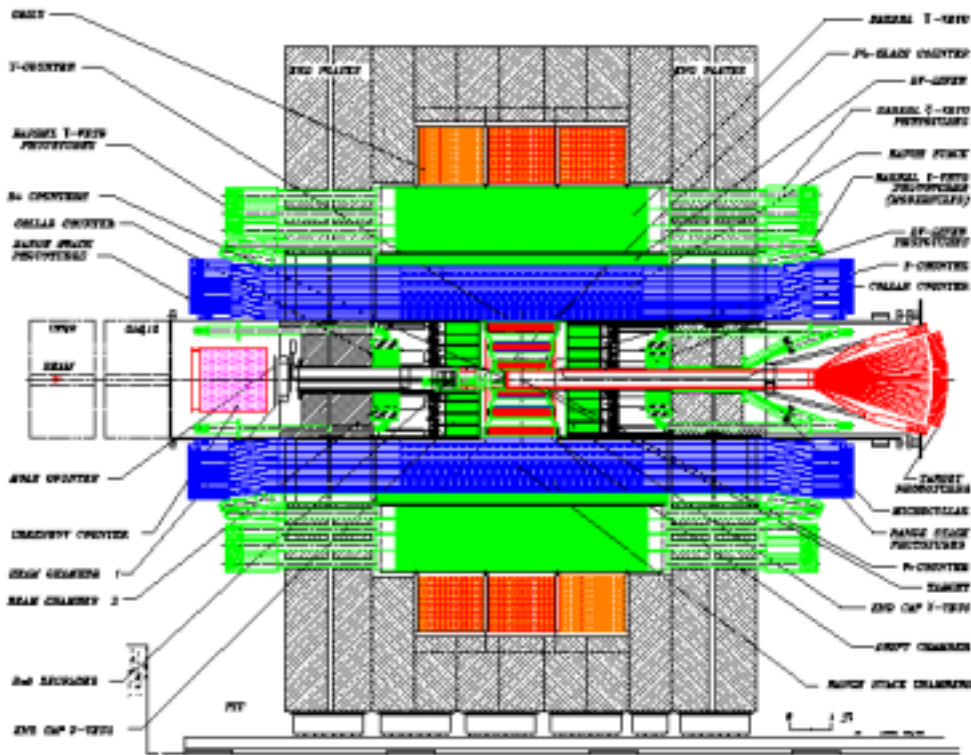

Special Features of Measuring $K^+ \rightarrow \pi^+ \nu \bar{\nu}$

Background processes may exceed signal by $>10^{10}$

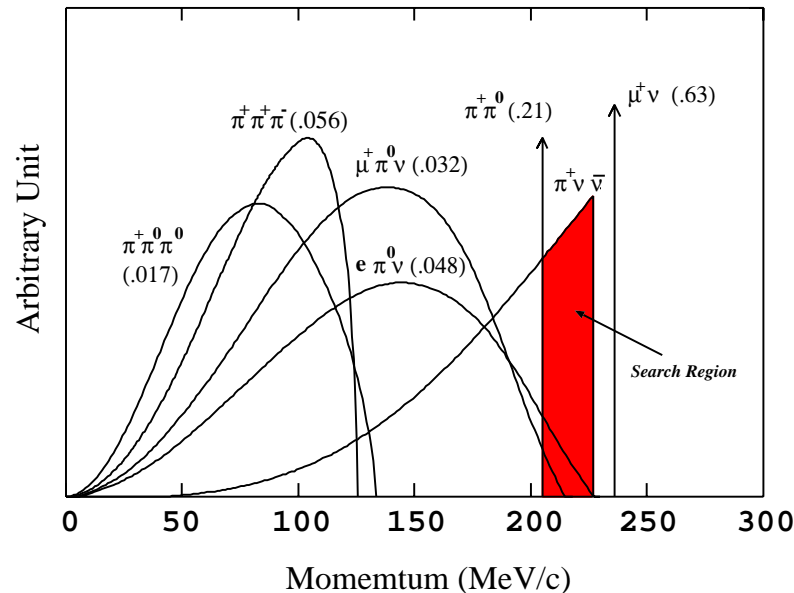

- Determine everything possible about the K^+ and π^+
 - * π^+/μ^+ particle ID better than 10^6 ($\pi^+-\mu^+-e^+$)
- Eliminate events with extra charged particles or *photons*
 - * π^0 inefficiency $< 10^{-6}$
- Suppress backgrounds well below the expected signal (S/N~10)
 - * Predict backgrounds *from data*: dual independent cuts
 - * Use “Blind analysis” techniques
 - * Test predictions with “outside-the-box” measurements
- Evaluate candidate events with S/N function

Background Processes: Range vs. Momentum

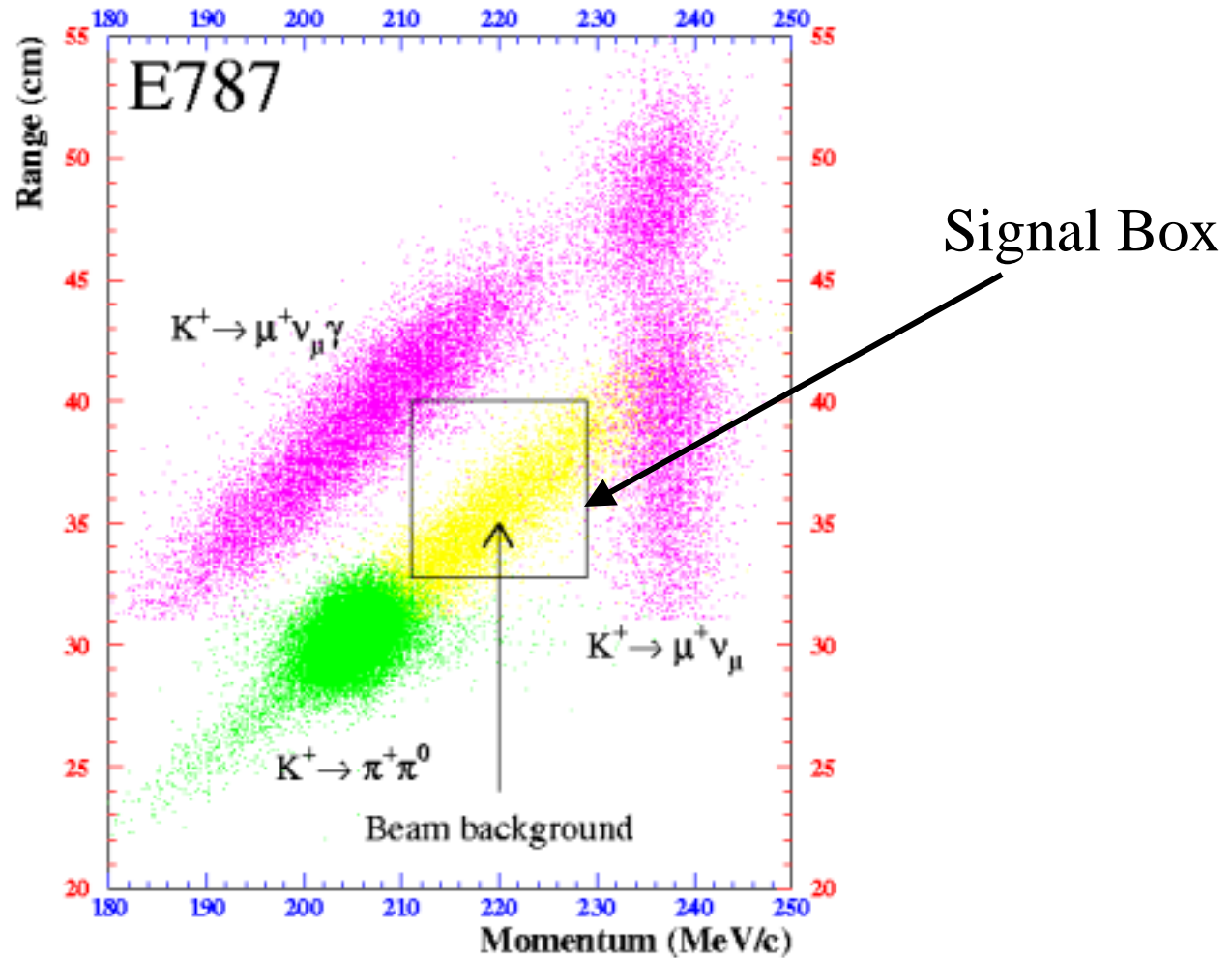

Decay Sequence Measurements 500 MHz Transient Digitizers

$K \rightarrow \pi$

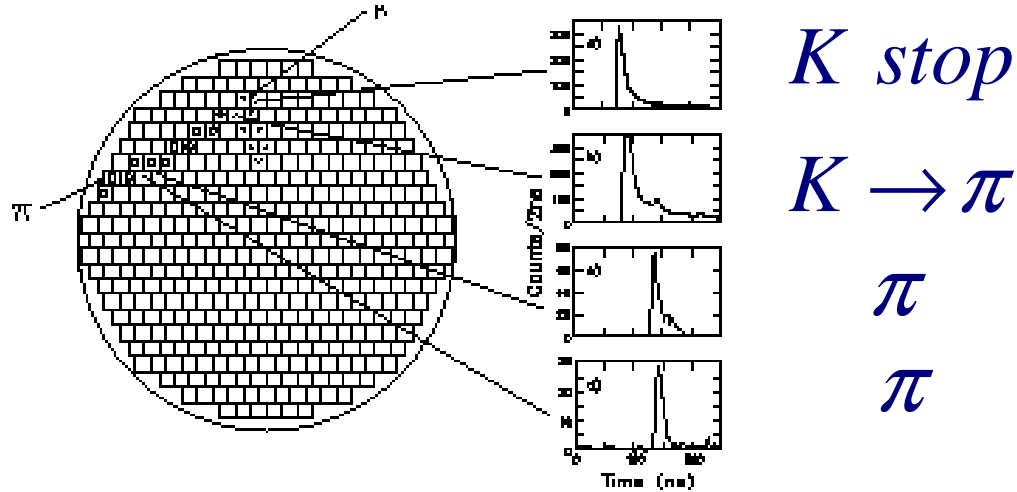

$\pi \rightarrow \mu \rightarrow e$

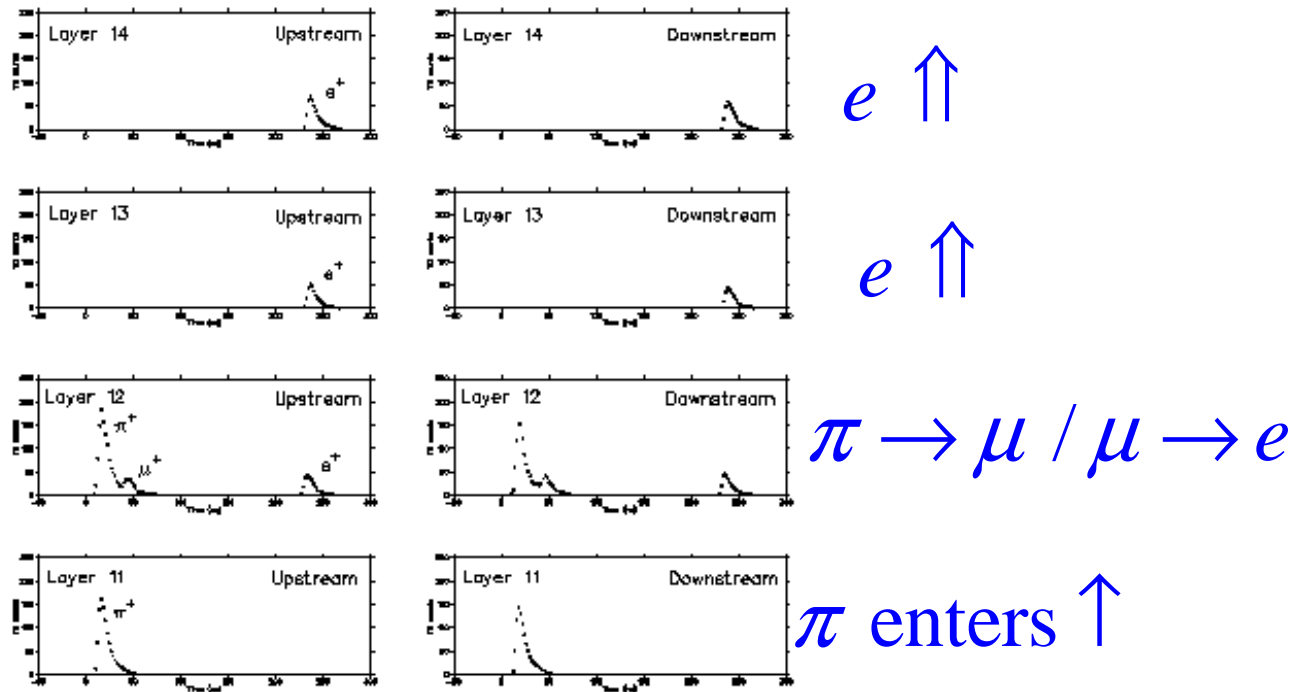

Dual Cut (Bifurcated) Analysis Method

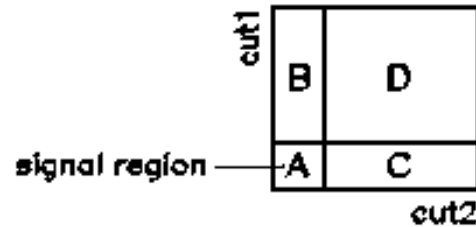

if cut1, cut2
uncorrelated,
 $A/B = C/D$
 $A = BC/D$

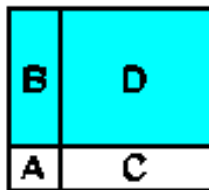

Invert cut1
 B+D events

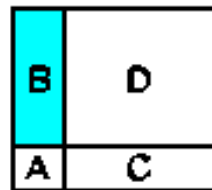

apply cut2
 B events

$$N = B$$

← Normalization branch

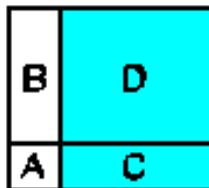

Invert cut2
 C+D events

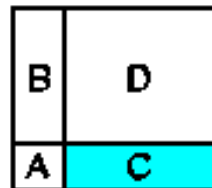

apply cut1
 $R = (C+D)/C$

$$bg = N/(R-1) = BC/D$$

← Rejection branch

predict
 $bg' = BC'/D' - BC/D$

mask out box
 and observe

outside-the-box region

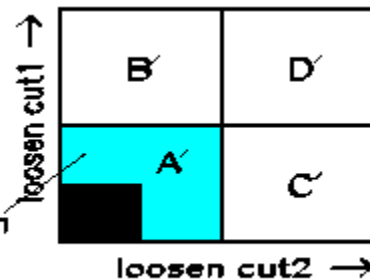

$K^+ \rightarrow \pi^+ \pi^0$ Background Suppression

Dual cuts: γ Veto and Kinematics (P,R,E...)

γ Veto Reversed

Range vs. Energy

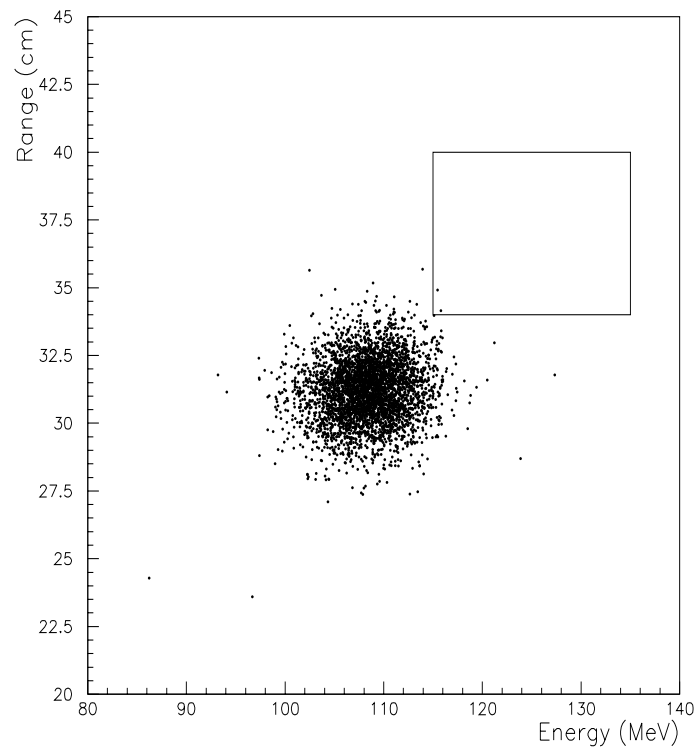

γ Veto Applied

Momentum

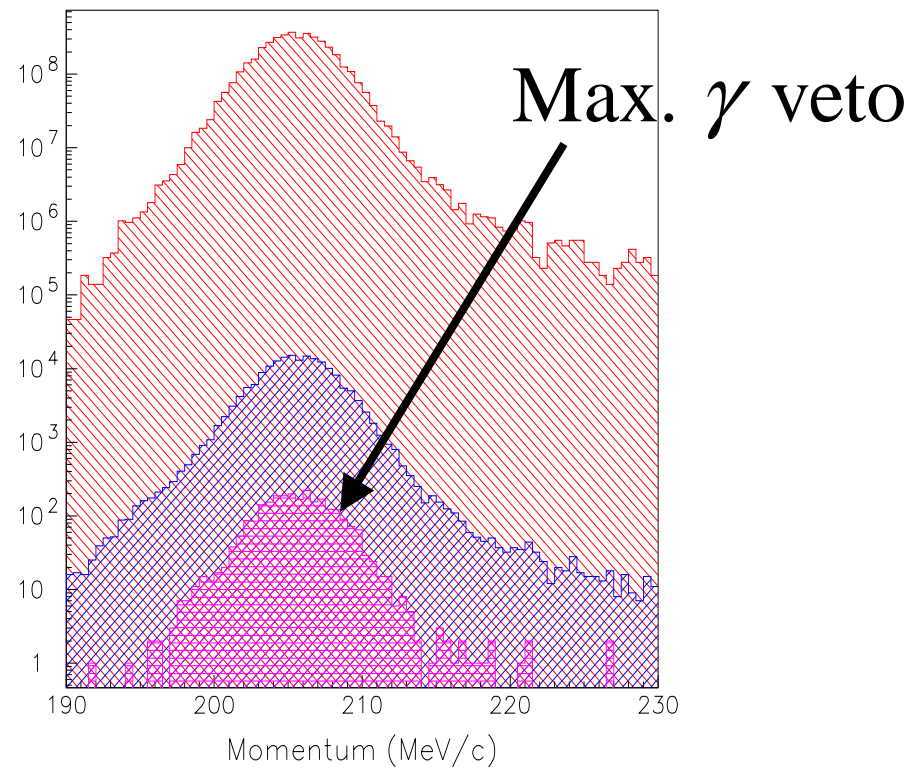

Check for correlations

Loosening the cuts to check for correlations

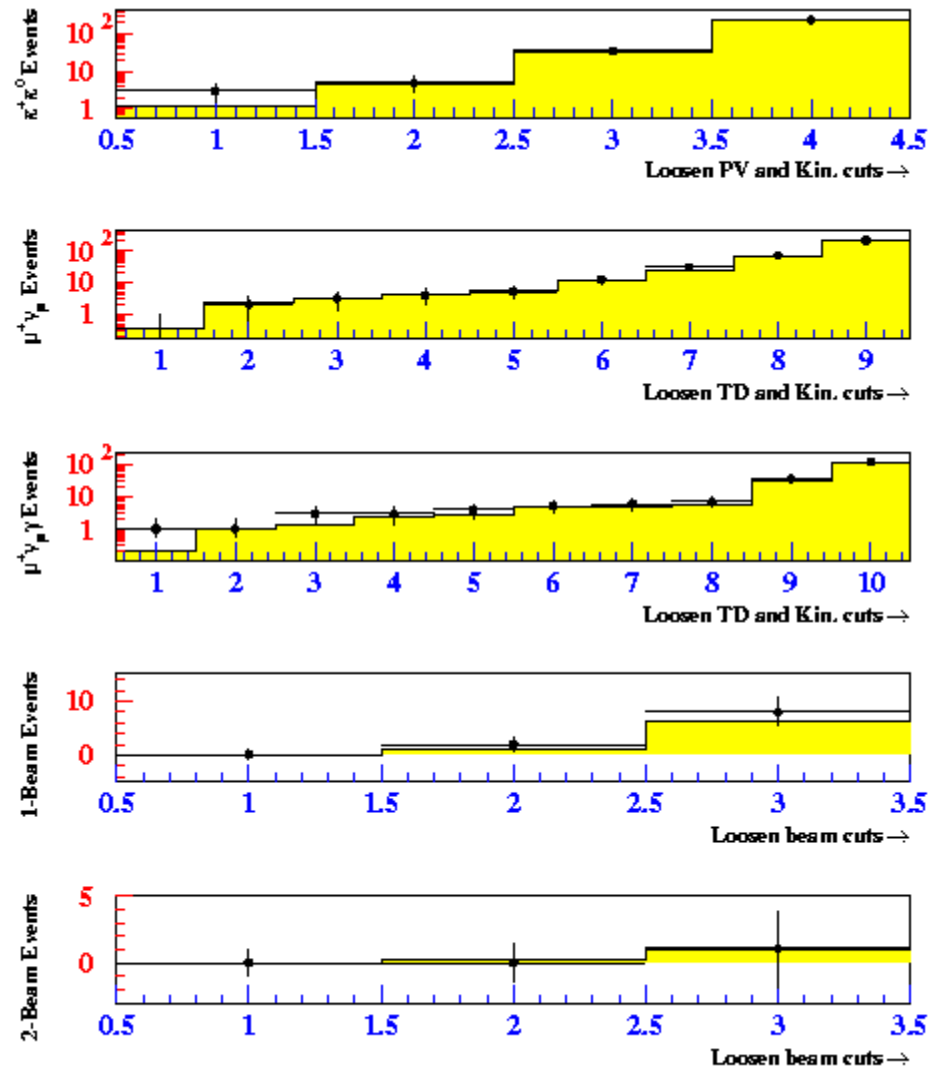

E787 Background Estimates

Source	Events

$K^+ \rightarrow \mu^+ \nu$	0.04 ± 0.01
$K^+ \rightarrow \pi^+ \pi^0$	$0.05 \pm_{0.03}^{0.04}$
Beam π	0.02 ± 0.02
Charge exch.	0.03 ± 0.01

Total	$0.15 \pm_{0.04}^{0.05}$

$$N_{K^+} = 5.9 \times 10^{12} \quad \text{Efficiency } \epsilon = 2 \times 10^{-3}$$

E787 2002: $Two K^+ \rightarrow \pi^+ \nu \bar{\nu}$ Candidates

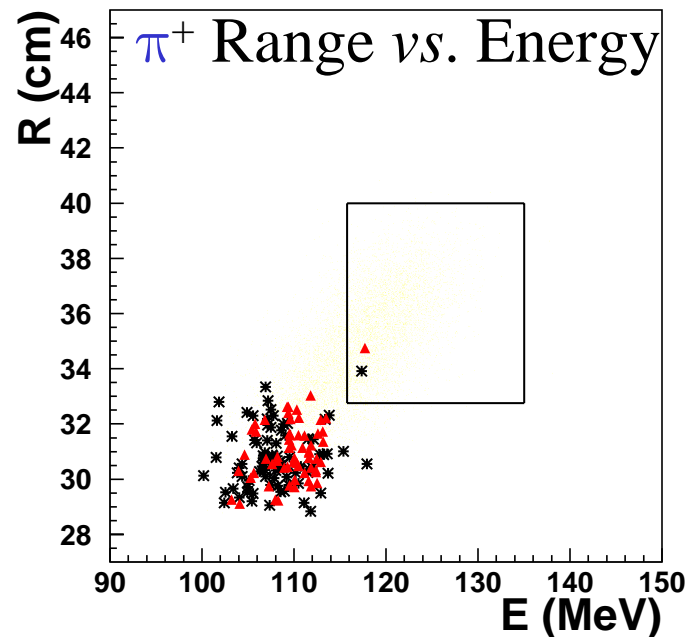
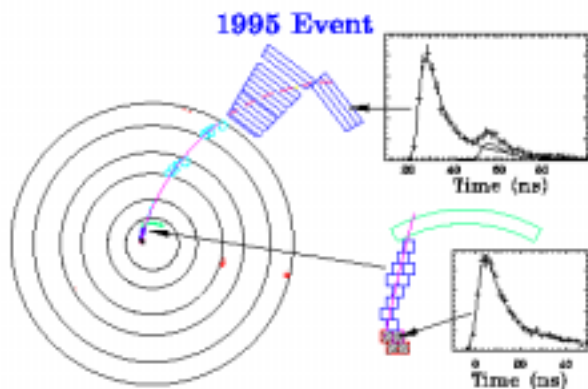

Event	P (MeV/c)	R (cm)	E (MeV)	S/N
1995	218.2	34.8	117.8	35
1998	213.8	33.9	117.1	3.6

$$N_{K^+} = 5.9 \times 10^{12} \quad \text{Efficiency } \epsilon = 2 \times 10^{-3}$$

Estimated Background: 0.15 ± 0.05 events

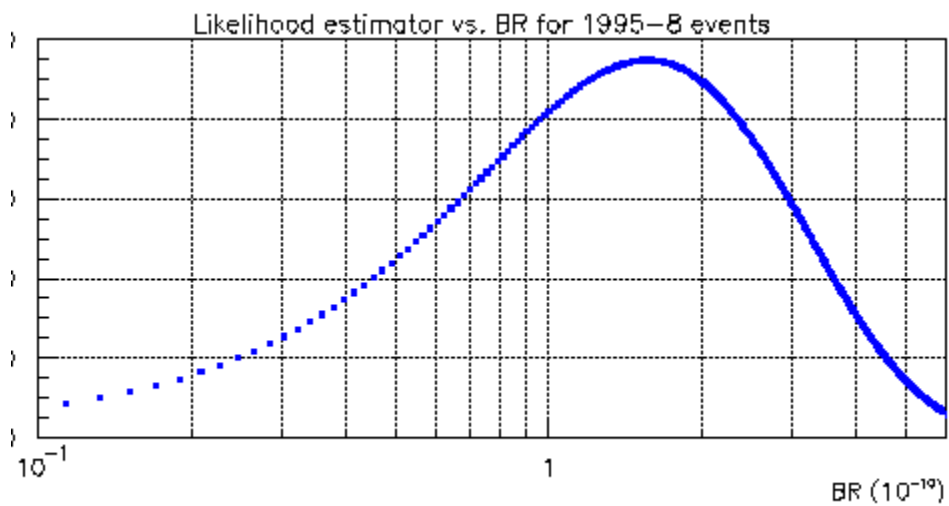
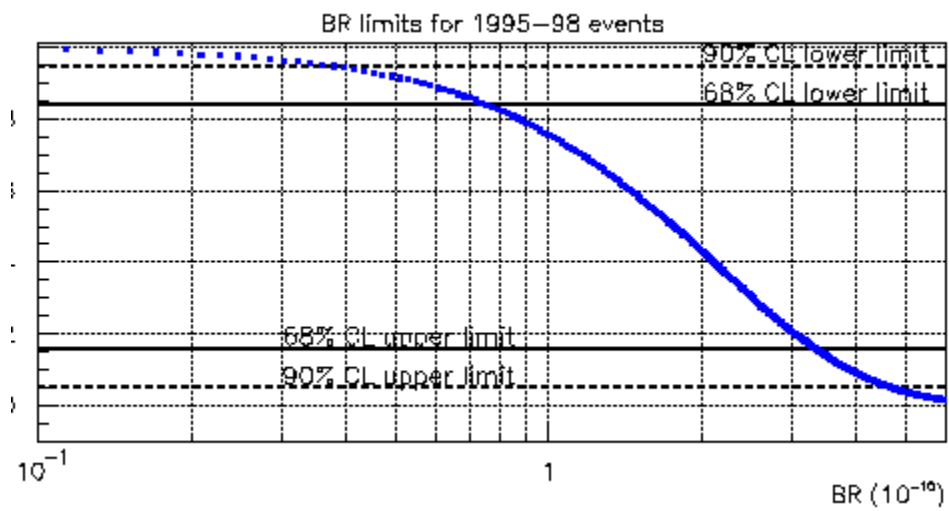

Branching Ratio

$$B(K^+ \rightarrow \pi^+ \nu \bar{\nu}) = 1.57 \pm_{0.82}^{1.75} \times 10^{-10}$$

Consistent with SM: $(0.72 \pm 0.21) \times 10^{-10}$

Estimated probability of being due to background only : 0.02%

Limits on $\lambda_t \equiv V_{ts}^* V_{td}$ (Independent of B system, ϵ_K, ϵ')

$$2.9 \times 10^{-4} < |\lambda_t| < 1.2 \times 10^{-4} \quad (68\% \text{ C.L.})$$

$$-0.88 \times 10^{-3} < \text{Re}(\lambda_t) < 1.2 \times 10^{-3} \quad (68\% \text{ C.L.})$$

$$\text{Im}(\lambda_t) < 1.1 \times 10^{-3} \quad (90\% \text{ C.L.})$$

Impact of E787 and E949 on Flavor Physics

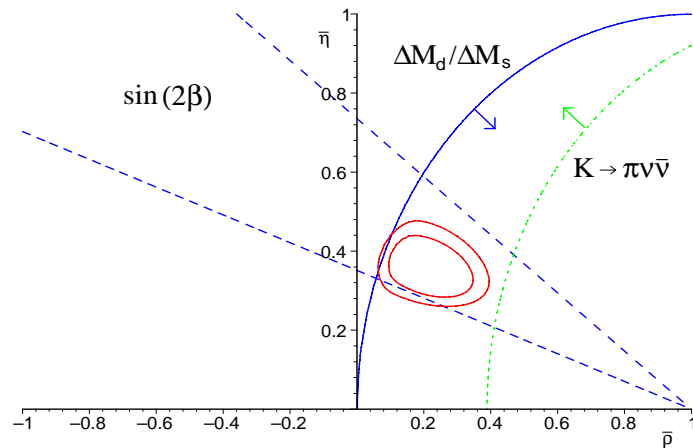

Figure 2: Allowed region in the $\bar{\rho} - \bar{\eta}$ plane using only theoretically *clean* observables: 90% C.L. interval imposed by $\sin(2\beta)$ (dashed); 90% C.L. limit from the upper bound on $\Delta M_{B_d}/\Delta M_{B_s}$ (full); 90% C.L. limit from the lower bound on $\mathcal{B}(K^+ \rightarrow \pi^+ \nu \bar{\nu})$ (dotted). For comparison the 68% and 90% C.L. ellipses from the global fit in Fig. 1 are also shown.

E949 at the
 E787 BR

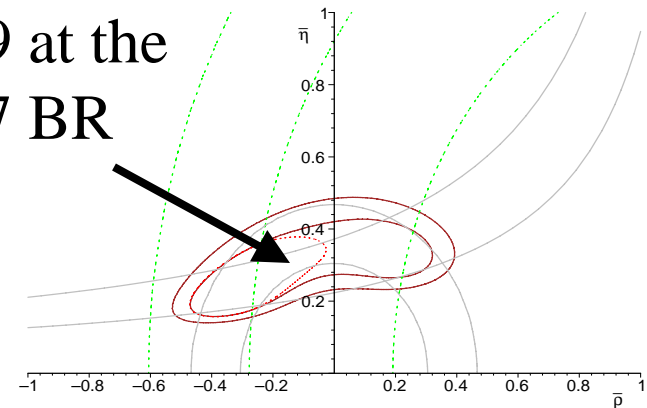
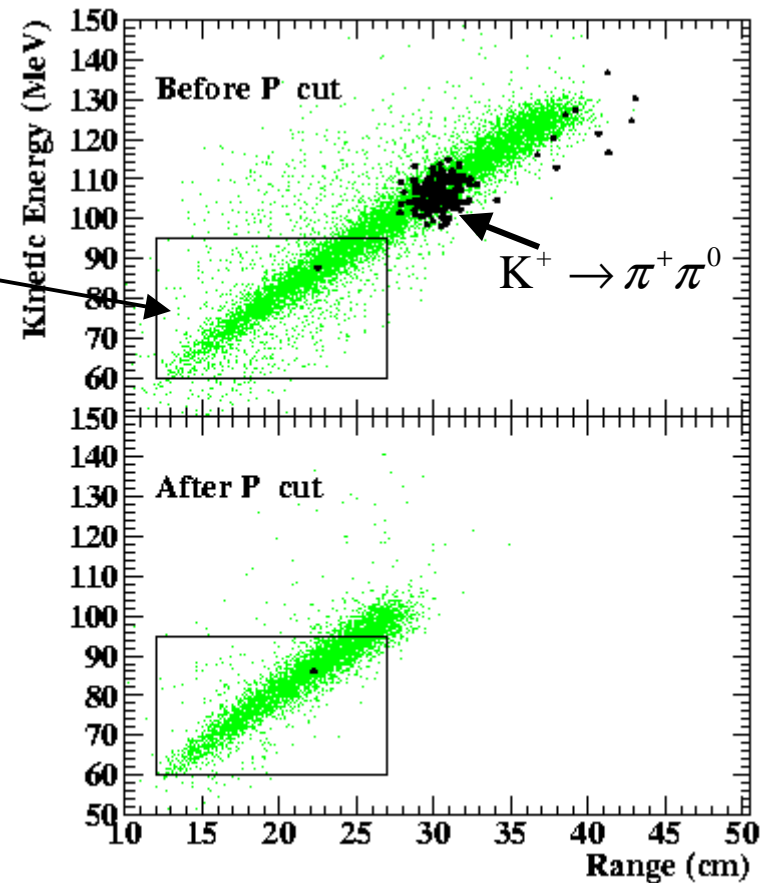
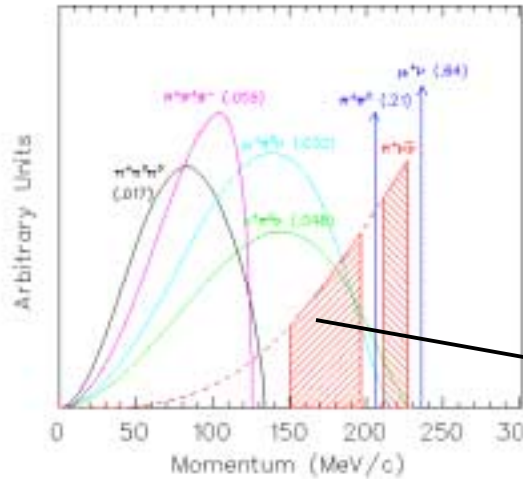

Figure 3: Allowed region in the $\bar{\rho} - \bar{\eta}$ plane with the inclusion of $\mathcal{B}(K^+ \rightarrow \pi^+ \nu \bar{\nu})$ and without $B_d - \bar{B}_d$ data. The two external contours denotes 68% and 90% confidence intervals; the inner (dotted) one is the 68% confidence interval under the assumption that experimental error in (1) is reduced by a factor two.

E787 and other clean
 observables (90% CL)

Possible E949 result
 favoring Non-SM

Search for $K^+ \rightarrow \pi^+ \nu \bar{\nu}$ below the $K_{\pi 2}$ Peak



1996 Data set:

$$N_K = 1.12 \times 10^{12}$$

$$\text{Acceptance: } 0.8 \times 10^{-3}$$

Estimated backgrounds: (events)

$$[K^+ \rightarrow \pi^+ \pi^0] \quad 0.73 \pm 0.18$$

Observation: **1**

$$R(K^+ \rightarrow \pi^+ \nu \bar{\nu}) < 4.2 \times 10^{-9}$$

$K^+ \rightarrow \pi^+ x$ and Global Family Symmetry

[Wilczek (1982), Gelmini et al. (1983), Feng et al. (1998)]

Motivation: Explain the replication of families

Postulate: Global Family Symmetry spontaneously broken at large mass scale $(F) \rightarrow$ Goldstone Boson "FAMILON (f)".

$$L_{eff} = \frac{1}{F} J_\mu \delta_\mu f :: \mu \rightarrow e + f \text{ and } s \rightarrow d + f$$

	GFS	Experiment	F Limit (GeV)
$B(K^+ \rightarrow \pi^+ f)$	$\frac{1.310^{14} \text{GeV}^2}{F^2}$	$< 5.910^{-11}$ (E787) (2002)	$> 210^{12}$
$B(\mu \rightarrow e f)$	$\frac{2.510^{14} \text{GeV}^2}{F^2}$	$< 2.610^{-6}$ (Jodidio)	$> 10^{10}$
$B(\tau \rightarrow e f)$	$\frac{2.510^{14} \text{GeV}^2}{F^2}$	$< 2.610^{-3}$ (ARGUS)	$> 310^6$
COSMOLOGY			$10^9 < F < 10^{12}$

Limits on $K \rightarrow \pi X$

Familon / Axion mass

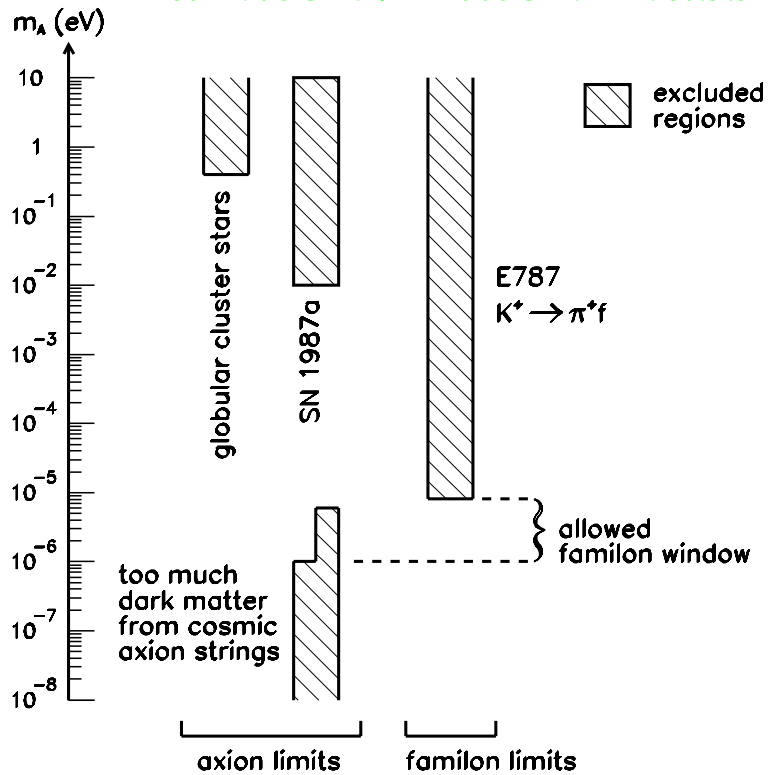

Branching Ratio vs. m_X

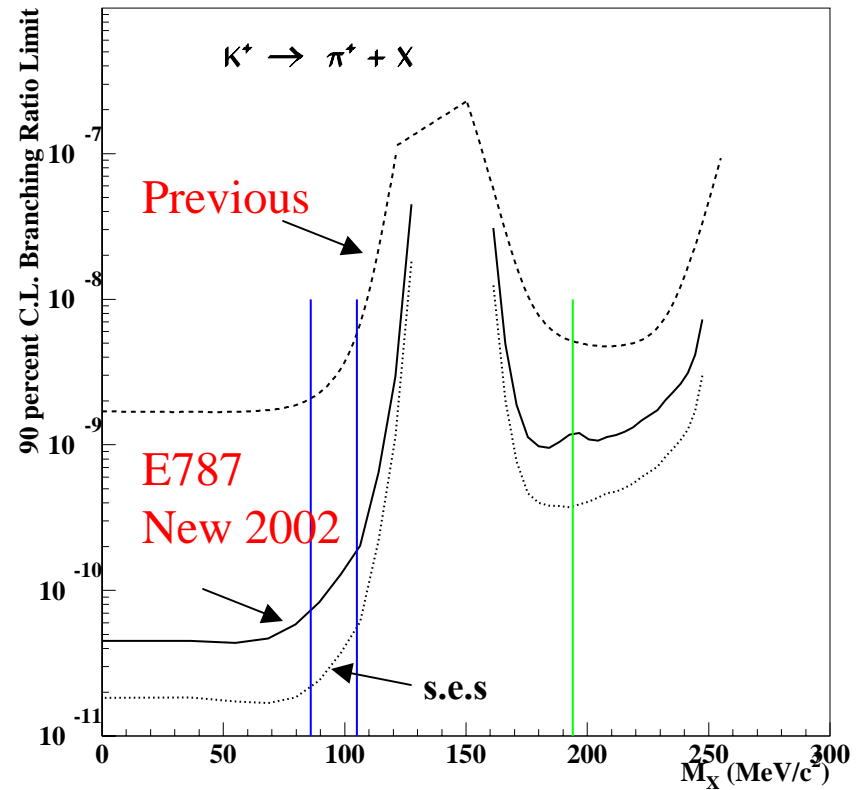

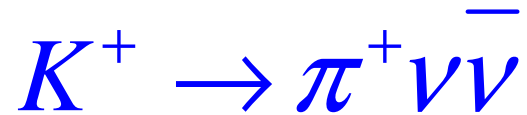

Future Prospects

BNL E949 (2002-)

Upgrade of E787 detector

Improved photon vetos – truly hermetic coverage

Access to the low momentum region

Sensitivity goal: $<10^{-11}$

Order of magnitude improvement beyond E787

Factor 5-10 below the SM prediction

μ^+ Momentum from $K^+ \rightarrow \mu^+ \nu$

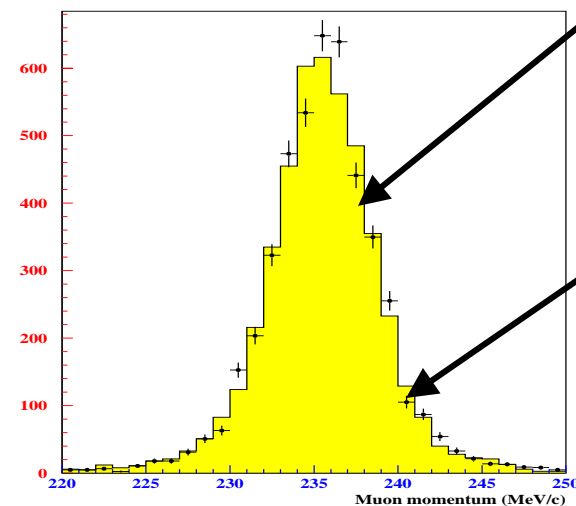

E949 at
2x rate
of
E787

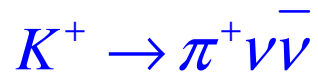

FNAL CKM (~2007-)

New *in-flight* technique - RF-separated K beam

Particle ID : RICH

Sensitivity goal: $<10^{-12}$

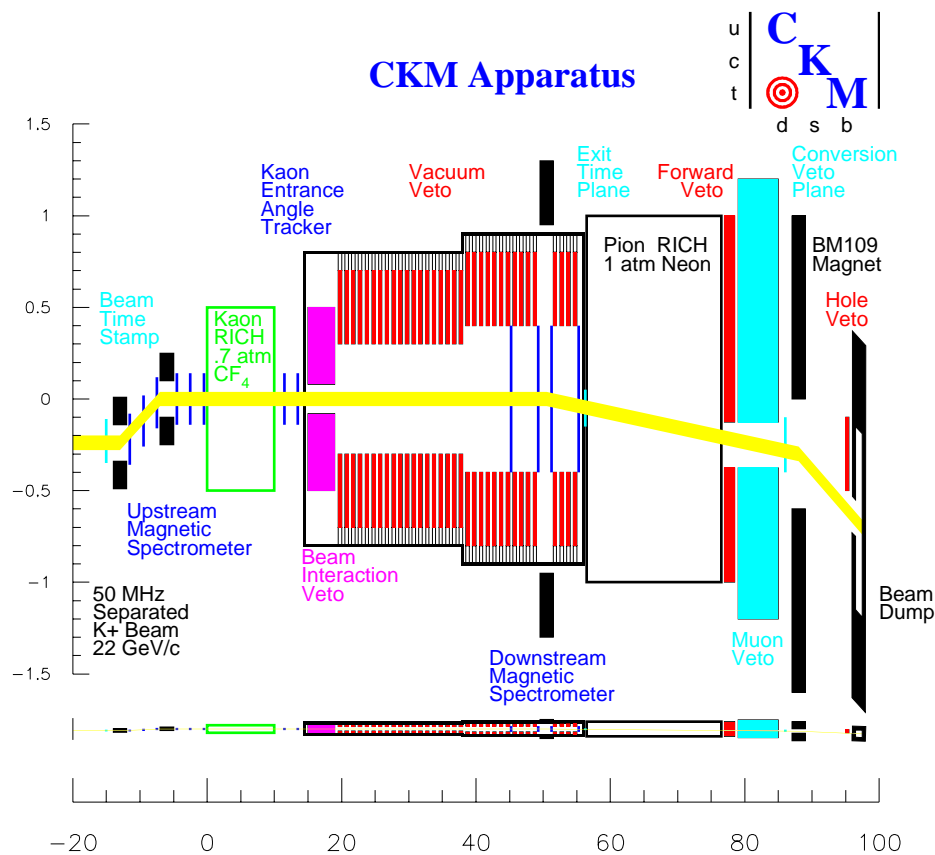

Momentum simulation:
RICH vs Tracking

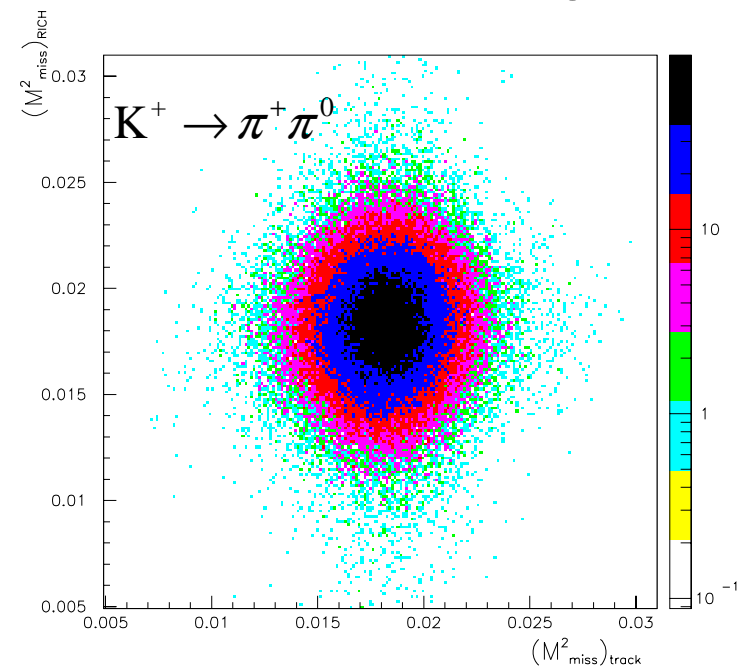

$M^2_{missing}$

CKM Goal: 100 events with $S/N > 7$

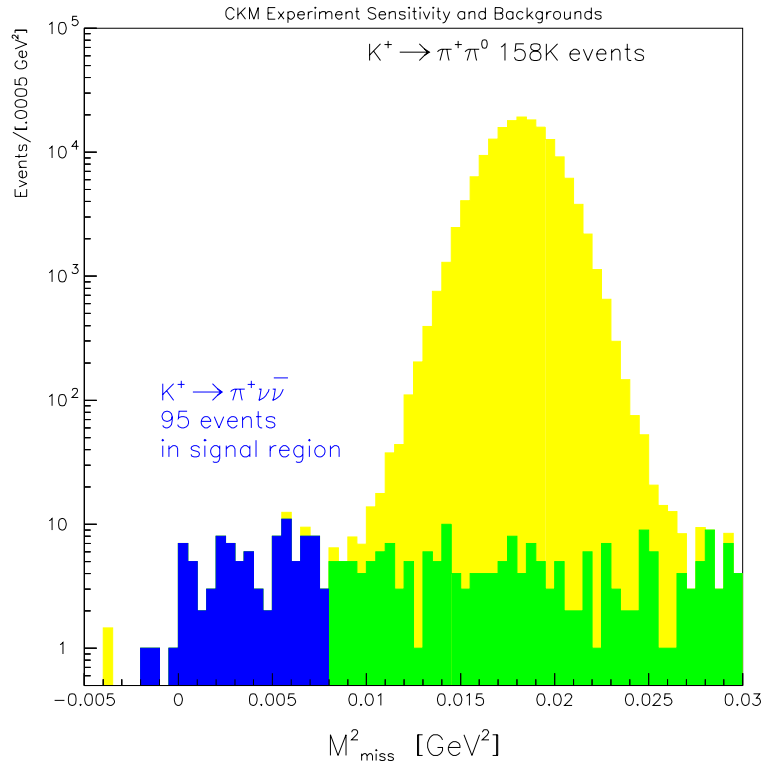

Background source	Effective BR ($\times 10^{-12}$)
$K^+ \rightarrow \mu^+ \nu_\mu$	< 0.04
$K^+ \rightarrow \pi^+ \pi^0$	3.7
$K^+ \rightarrow \mu^+ \nu_m u \gamma$	< 0.09
$K^+ A \rightarrow K_L X, K_L \rightarrow \pi^+ e^- \bar{\nu}_e$	< 0.14
$K^+ A \rightarrow \pi^+ X$ in trackers	< 4.0
$K^+ A \rightarrow \pi^+ X$ in residual gas	< 2.1
Accidentals (2 K^+ decays)	0.51
Total	< 10.6

$K^+ \longrightarrow \pi^+ \nu \bar{\nu}$ Measurements vs. Year

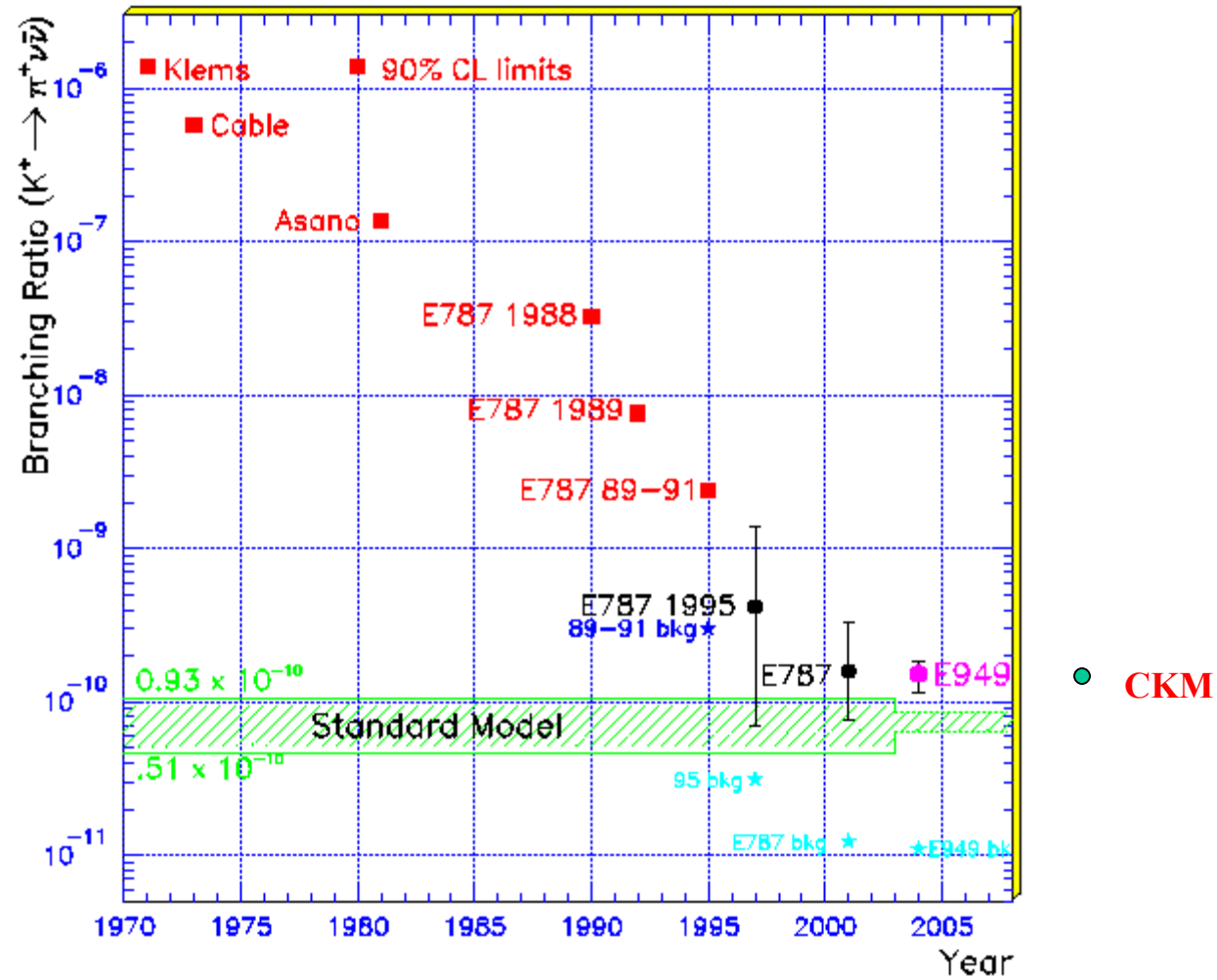

Probing CP Violation with Rare Kaon Decays

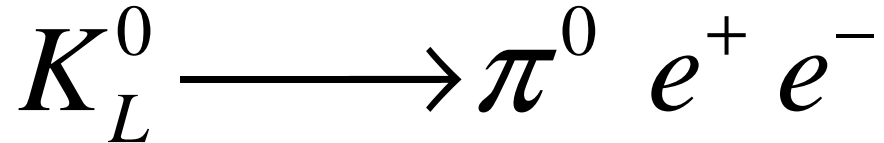

Difficult to get at *short distance* physics due to long distance strong interaction effects and other complications. **Progress is being made.**

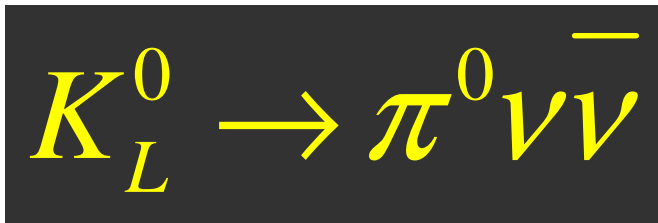

The Golden Mode! – but can it be measured?

SM Prediction: $\mathcal{R}(K_L^0 \rightarrow \pi^0 \nu \bar{\nu}) \sim 4.1 \times 10^{-10} A^4 \eta^2 = 2.6 \pm 1.2 \times 10^{-11}$

Experiments seeking $K_L^0 \rightarrow \pi^0 \nu \bar{\nu}$

- Limit based on isospin and $K^+ \rightarrow \pi^+ \nu \bar{\nu} : < 1.7 \times 10^{-9}$ • [Grossman, Nir]

- KTEV (FNAL) result:

$$R(K_L^0 \rightarrow \pi^0 \nu \bar{\nu}) \equiv \frac{\Gamma(K_L^0 \rightarrow \pi^0 \nu \bar{\nu})}{\Gamma(K_L^0 \rightarrow all)} < 5.9 \times 10^{-7}$$

- KEK E391a *goal* : s.e.s. 10^{-10} – 10^{-9}

- KOPIO (BNL) *goal* : s.e.s. $< 10^{-12}$, > 50 events



Primary Background: $K_L^0 \rightarrow \pi^0 \pi^0$ $R(K_L^0 \rightarrow \pi^0 \pi^0) \sim 10^{-3}$

Photon Vetoing

E787

$$\bar{\epsilon}_\gamma \sim 10^{-2} \text{ (20-100 MeV)}$$

$$\sim 10^{-4} \text{ (100-220 MeV)}$$

$$\bar{\epsilon}_{\pi^0} < 10^{-6}$$

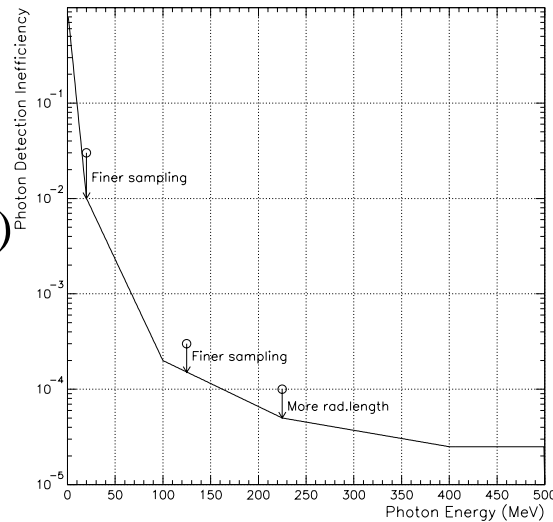

KEK *Photonuclear*
Inefficiency of γ detection

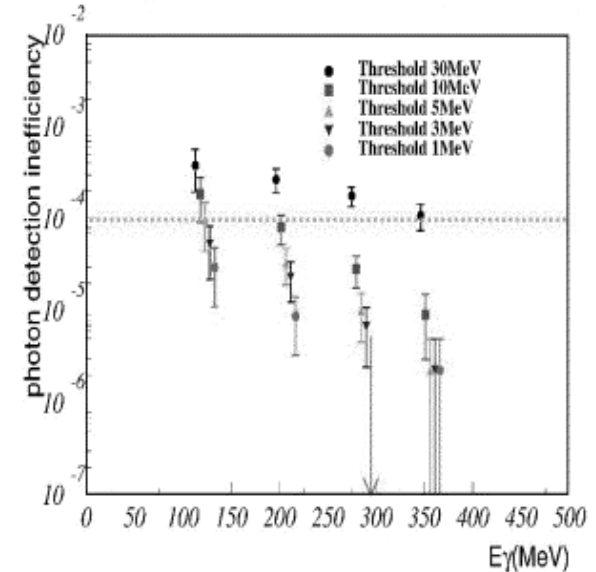

Photon vetoing & Kinematics:
Suppress events with low energy photons

Missing mass ($2E_1^{miss} E_2^{miss} \cos\theta_{12}$) vs.
Missing energy ($E_1^{miss} + E_2^{miss}$)

$$\bar{\epsilon}_{\pi^0} < (10^{-4})(10^{-4}) = 10^{-8}$$

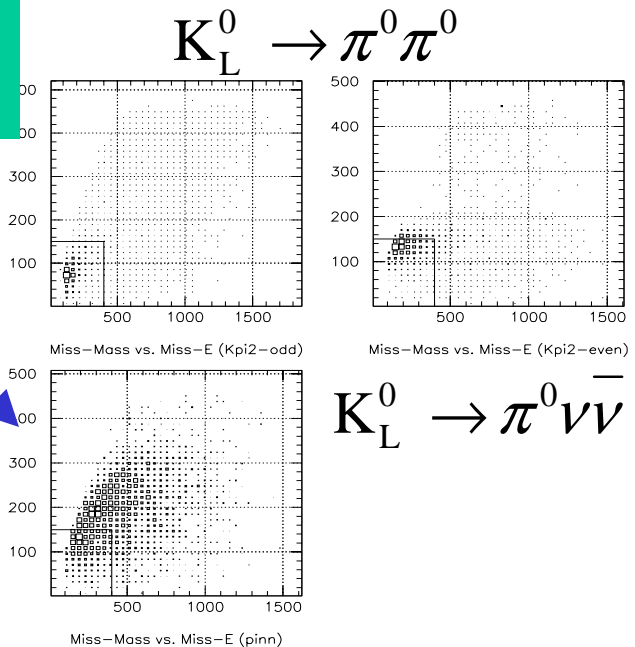

Charged Particle Vetoing

Example Background: $K_L^0 \rightarrow \pi^- e^+ \nu \gamma$

Plastic Scintillator



PSI Measurement

KEK: 1 GeV/c

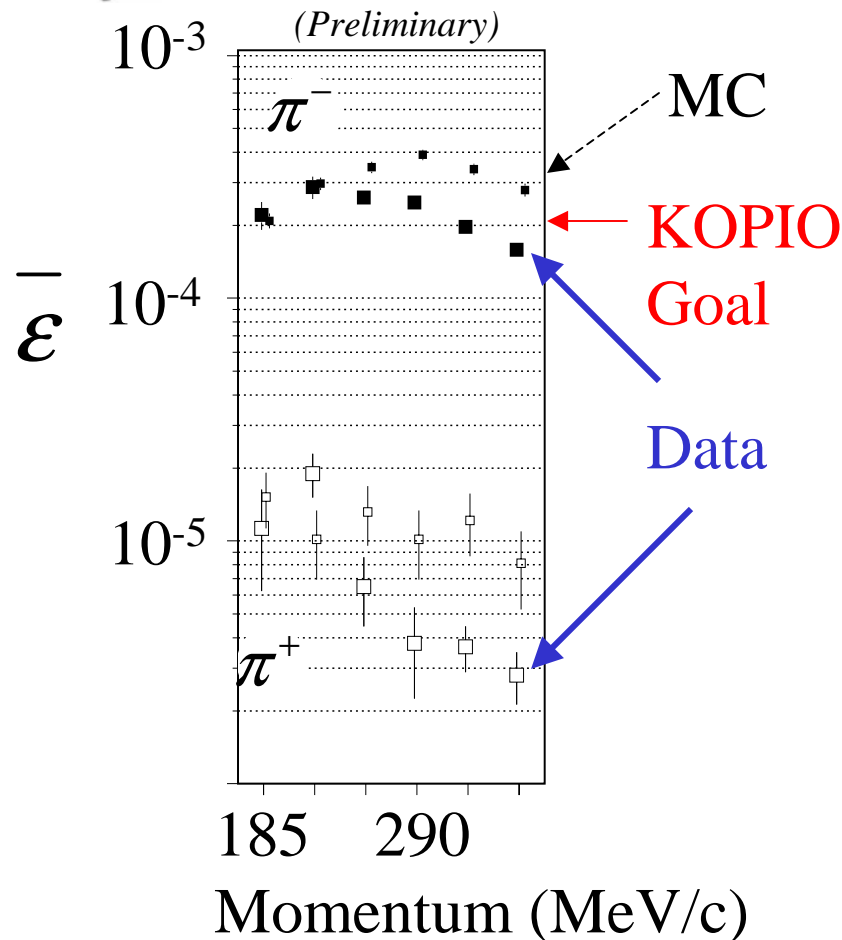

Particle	$\bar{\epsilon}$
e^+	$(3.2 \pm 0.9) \times 10^{-4}$
π^+	$< 1.6 \times 10^{-5}$
e^-	$< 1.3 \times 10^{-4}$
π^-	$(6.0 \pm 0.6) \times 10^{-4}$

NIM A359, 478 (1995)

E391a Detector Setup

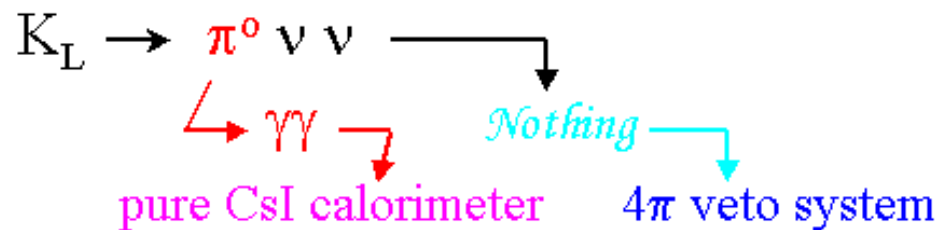
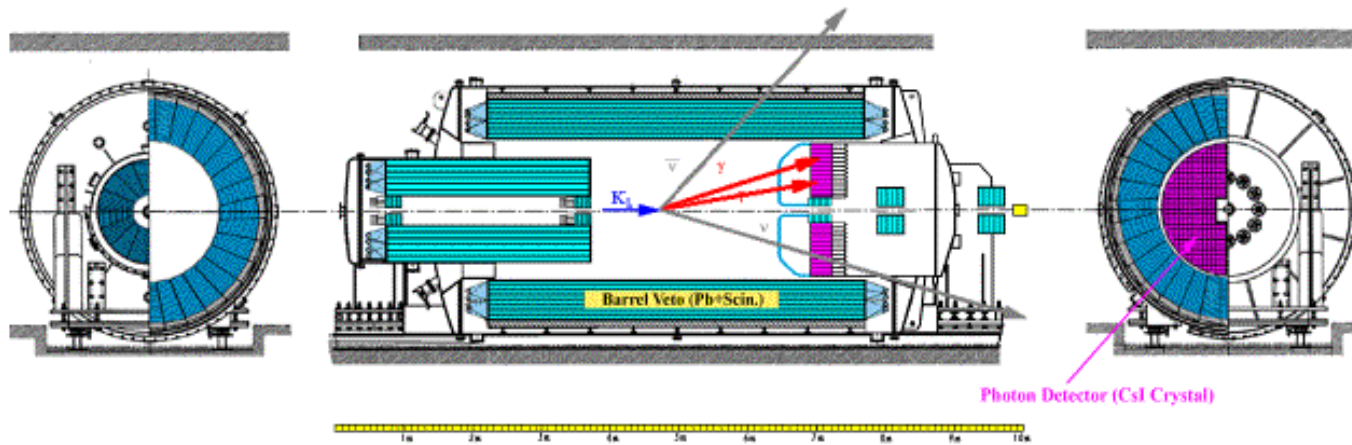

- Features:
- * Pencil Beam
 - * High acceptance
 - * High P_T selection

- * Pilot Project for JHF
- * Test reliance on extreme photon veto efficiency

KEK Neutral Beam Measurements

H. Watanabe (2002)

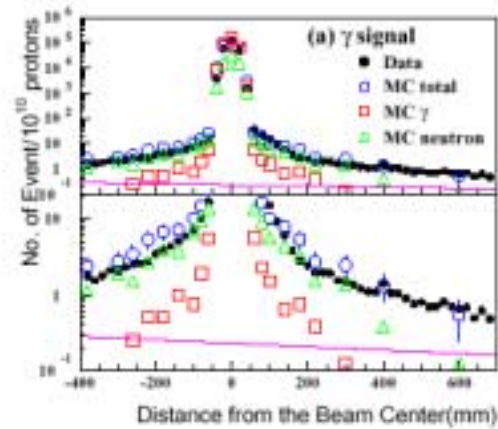

Neutrons

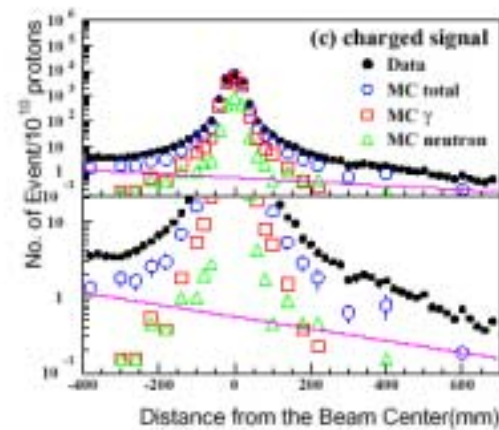
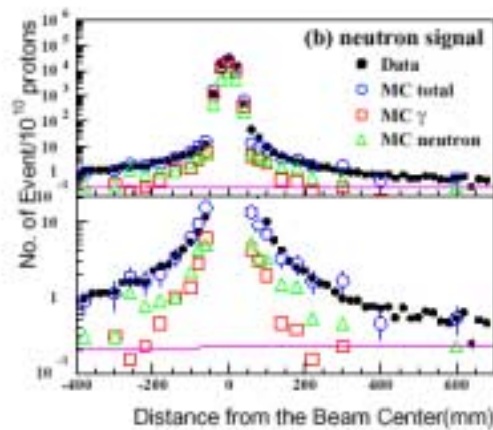



KOPIO: Measurement of $K_L^0 \rightarrow \pi^0 \nu \bar{\nu}$

CONCEPTS

- Measure as much as possible:
Energy, position and *ANGLE* of each photon.
- Work in the C.M. system :
Use TOF to get the K_L^0 momentum.
- Maximize Photon Veto Efficiency
- Maximize Intensity of Microbunched Beam

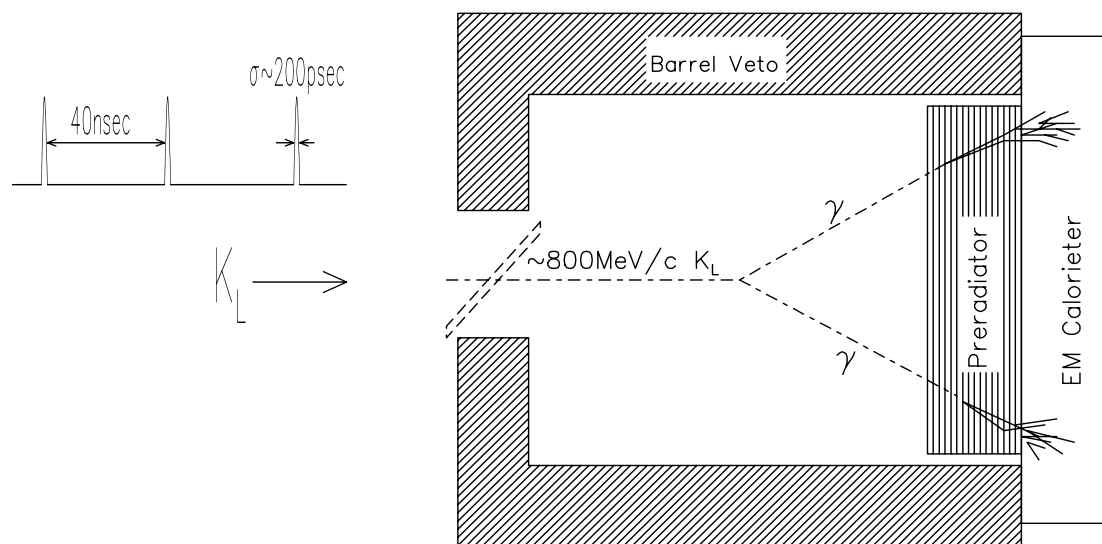

KOPIO Beam and Constraints

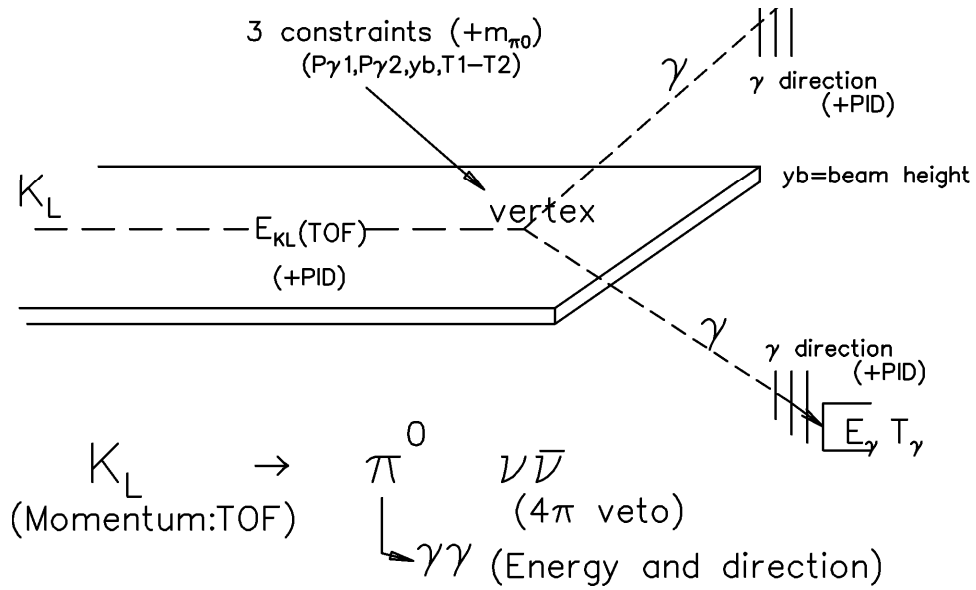



Shashlyk calorimeter

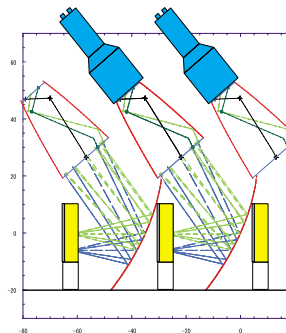
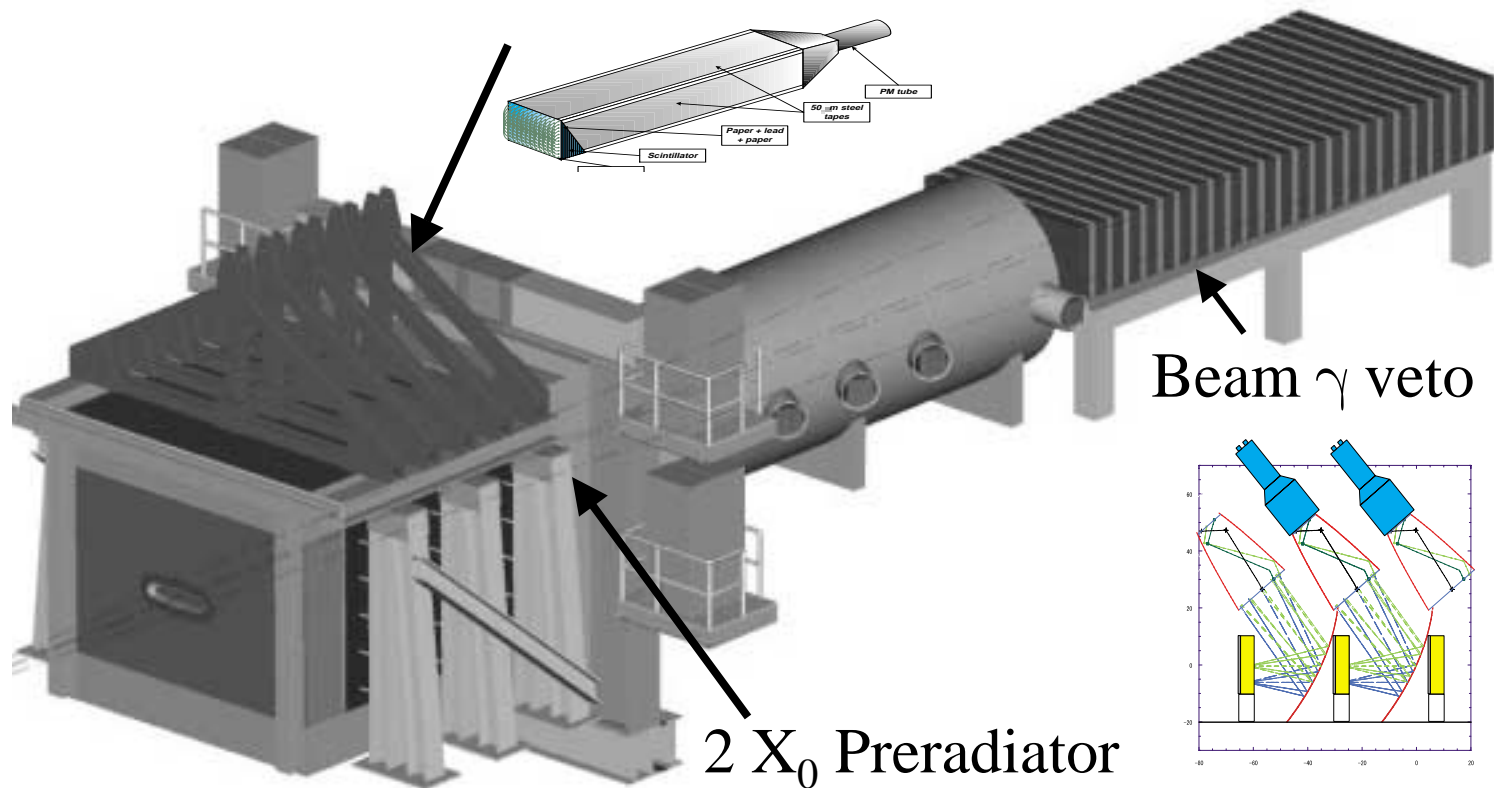

Parameter	Minimal Requirement	Expected Performance
E_γ resolution	$3.5\%/\sqrt{E}$	$2.7\%/\sqrt{E}$
θ_γ resolution (250MeV)	(25 – 30) mr	23 mr
t_γ resolution	$100ps/\sqrt{E}$	$50ps/\sqrt{E}$
x_γ, y_γ resolution(250MeV)	10mm	< 1mm
μ -bunch width	300ps	200ps
γ -veto inefficiency	$\bar{\epsilon}_{E787}$	$0.3\bar{\epsilon}_{E787}$

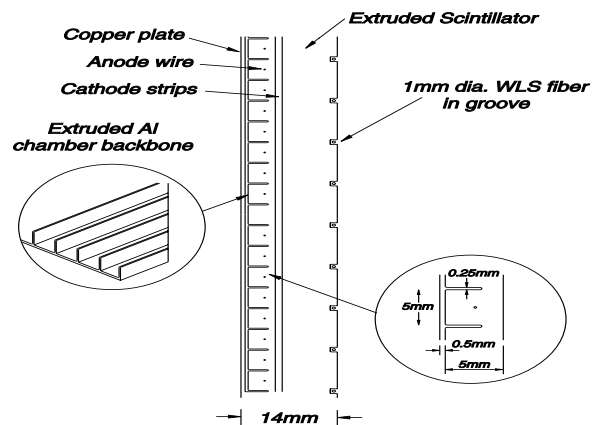

KOPIO Prototype Measurements – Tagged Photon Beams

Preradiator

Angular resolution:
25 mr at 250 MeV/c

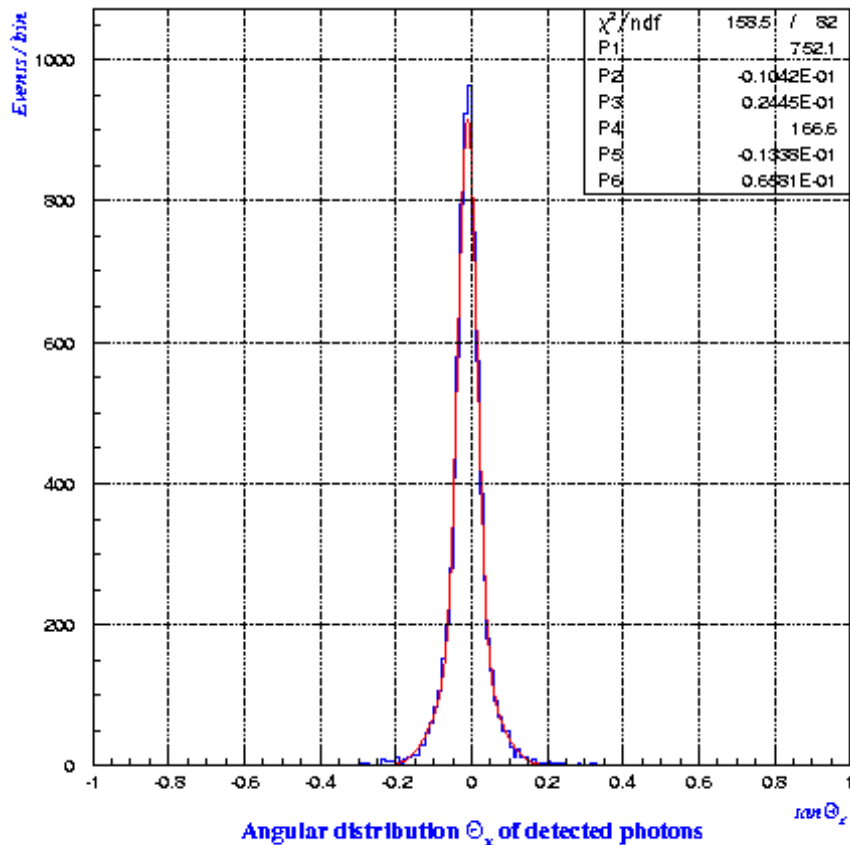

Shashlyk

Calorimeter resolution:
<4% at E=1 GeV

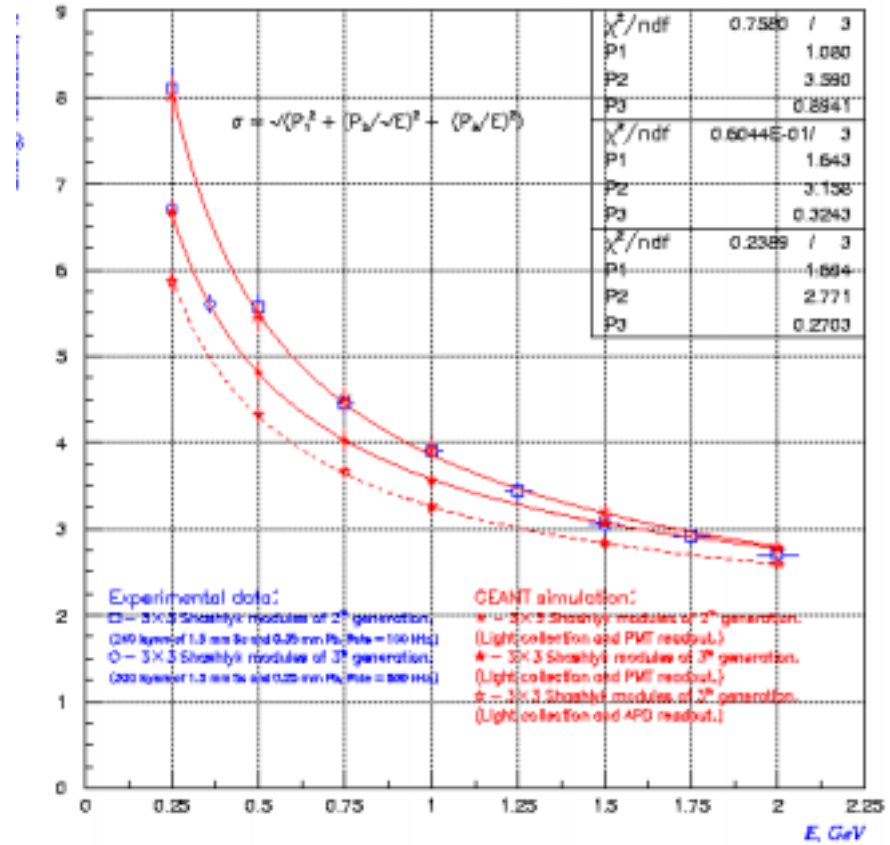

Simulation: Combined Energy Resolution

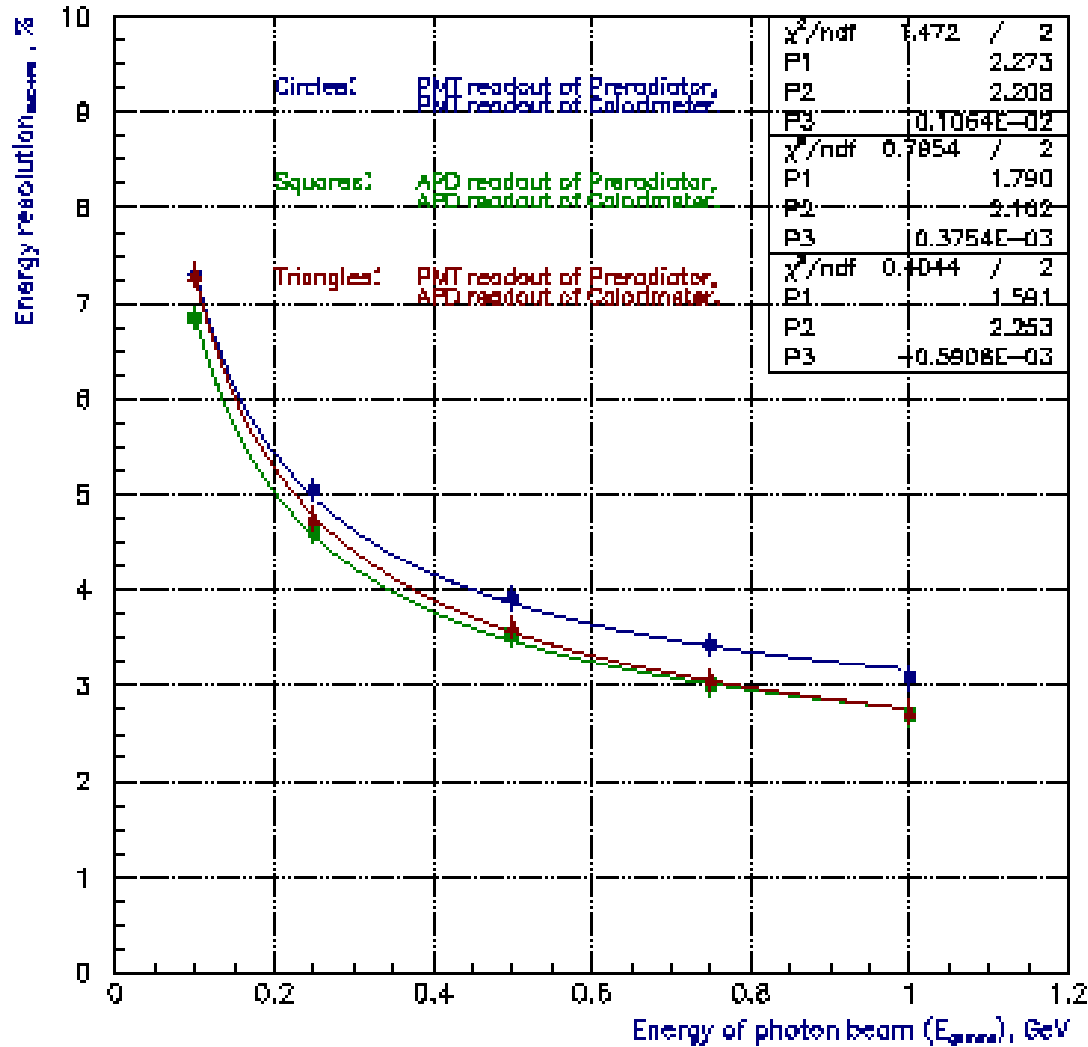

$$\sigma \sim \frac{3\%}{\sqrt{E(\text{GeV})}}$$



Kinematic suppression of backgrounds

Goal: >50 Events with S/N>2

$$E_{\pi^0}^* \text{ vs. } |E_{\gamma 1}^* - E_{\gamma 2}^*|$$

$K_L^0 \rightarrow \pi^0 \nu \bar{\nu}$

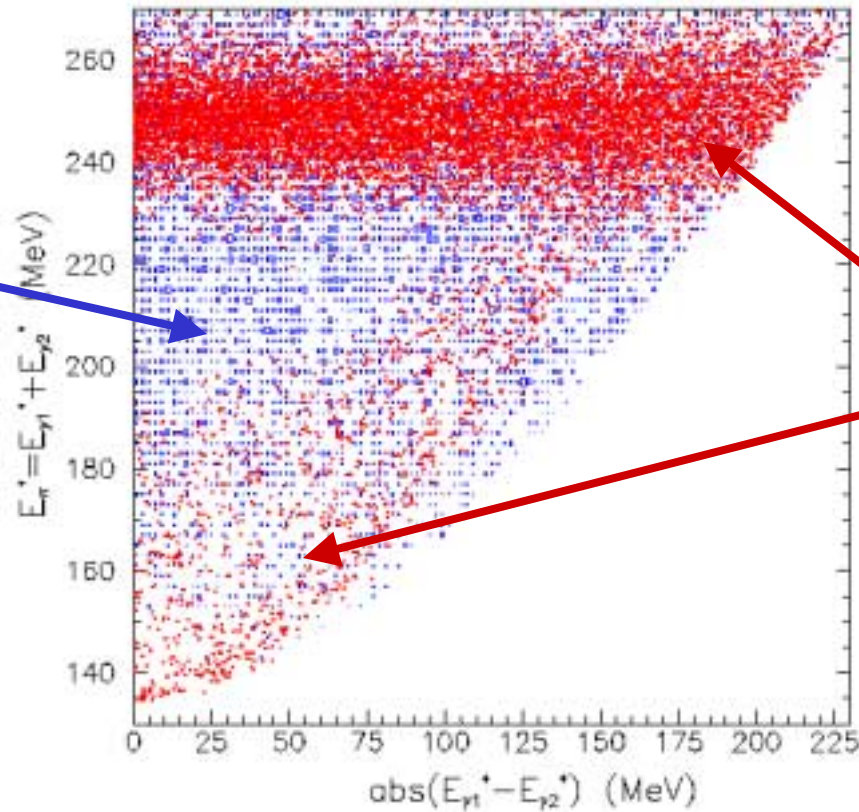

$K_L^0 \rightarrow \pi^0 \pi^0$

Summary and Outlook

- $K^+ \rightarrow \pi^+ \nu \bar{\nu}$: 2 events seen

$$B(K^+ \rightarrow \pi^+ \nu \bar{\nu}) = 1.57 \pm_{0.82}^{1.75} \times 10^{-10} \text{ (E787)}$$

Prospects: E949 (10 events) *in progress*

CKM (100 events) *200x*

- $K_L^0 \rightarrow \pi^0 \nu \bar{\nu}$ *Prospects :*

E391a (s.e.s. $< 10^{-9}$) *in progress*

KOPIO (50 events) *200x*

JHF? *201x*

- Exotics: New results on $K^+ \rightarrow \pi^+ x, K^+ \rightarrow \pi^+ \gamma$ (E787)